



NEBULA 5 / NEBULA 6 EQ/AZ MOUNT

USER MANUAL VER. 1.0



SAFETY RECOMMENDATIONS AND WARNINGS

- **Read carefully the manual before installing and using the mount.**
- **Use the power cable supplied with the mount or a 12V- 3,5 A stabilized power supply as suggested in the manual.**
- **Connect the power cable correctly and securely to the power socket.**
- **Do not bend, pull or press the cable as this may damage it.**
- **Be sure to remove the power supply at the end of its use or before any cleaning or maintenance.**
- **This mount must be used exclusively by adults, do not allow use to children or to people with reduced mental capacity.**
- **Avoid to operate the mount except as strictly indicated in the manual.**
- **Modifying or altering in any way the characteristics of the mount will void the manufacturer's limited warranty.**
- **For any assistance or repair, please contact only the manufacturer.**
- **After using it, avoid to store the mount in areas exposed to sunlight or in wet places.**

Table of contents

SAFETY RECOMMENDATIONS AND WARNINGS	2
Foreword.....	4
Nebula 5 Technical Specifications.....	5
Nebula 6 Technical Specifications.....	6
1. Packing Content	7
2. Nebula initial Setup.....	8
3 Latitude Range Adjustment.....	9
4 Installing the Nebula 6 on the Tripod	13
5. Install the mount on the tripod	16
6. Install the counterweight shaft	17
7. Install the counterweights	18
8. Install the Nebula the GoTo System on the Nebula Tripod	19
9. Motor cable connecting.....	21

Foreword

This manual describes the Nebula 5 and Nebula 6 mounts, the procedures for its mounting and tuning on the tripod and for the installation of a telescope. Additional Information on these mounts and on the Nebula GoTo System, containing also the procedures for the use with third-party software, are reported in the Nebula GoTo System manual.

The mounts are different just in the size side, so the installation and operation procedure can be considered basically the same. The few section with different procedures will be described in the corresponding paragraph.

A careful reading of this manual will enable the use of the mount safely and with the maximum satisfaction.

The mounts design and its configuration could be subject to modifications, without prior notification, based upon designer's improvements and the requests, if applicable, by the mount users.

Nebula 5 Technical Specifications

Type of mount	Equatorial Alt-azimuth mount
Mount weight	5 kg
Payload (excl. counterweight):	15 kg EQ for photographic use / 20 kg Alt-azimuth Mode
Construction Material	Aluminium CNC milled
External treatment:	anodised grey/green
RA Axis	Heavy duty steel, diam. 62mm; all roller bearing axis movement
DEC Axis	Heavy duty steel, diam. 62 mm; all roller bearing axis movement
Control System	Nebula GoTo System
Counterweight Bar	Quick release, 30mm diam. (1,181 "), stainless steel bar
Counterweight	1 x 6 kg (13,2 lb) stainless steel
Mount saddle	Losmandy & Vixen

Nebula 6 Technical Specifications

Type of mount	Equatorial Alt-azimuth mount
Mount weight	7,5 kg
Payload (excl. counterweight):	18 kg EQ for photographic use / 25kg Alt-azimuth Mode
Construction Material	Aluminium CNC milled
External treatment:	anodised grey/green
RA Axis	Heavy duty steel, diam. 35mm; all roller bearing axis movement
DEC Axis	Heavy duty steel, diam. 35mm; all roller bearing axis movement
Control System	Nebula GoTo System
Counterweight Bar	Quick release, 30mm diam. (1,181 "), stainless steel bar
Counterweight	1 x 6 kg (13,2 lb) stainless steel
Mount saddle	Losmandy & Vixen

1. Packing Content

In order to allow a safe shipment and provide to the user a complete setup ready to operate, the Nebula 6 comes in only one foam protected package, including mount, tripod, controller and other required accessories. The first operation to be made in order to use the product, is to unbox all the items and perform the basic mount adjustment, as the latitude range adjustment and the installing on the tripod.

Open the box to take all the content out. Extract all the components from the cardboard foam protected box and putting them on a clean, flat surface.

In order to provide a compact and safe package, the items has been placed in different layers, so, order to extract the mount, is necessary to take out the Nebula GoTo System package first.

The counterweight and the corresponding shaft are placed below the tripod, protected from a foam layer.

Component List





- | | |
|---|---|
| <ul style="list-style-type: none">• Mount• Tripod• Nebula GoTo System• Control Keypad• Counterweight shaft• 6 kg stainless steel counterweight | <ul style="list-style-type: none">• Keypad connecting cable• RA (66 cm) / DEC (85 cm) motors cables• Power supply• 2 x mount fixing knobs• 2 x Azimuth adjustment pin• 2 x M5 x 8 TCEI bolts |
|---|---|



2. Nebula initial Setup

In order to reduce as much as possible the overall size for shipment reasons, the mount is shipped with the RA axis upside down.

So, the first operation to perform is to turn the RA axis 180° in order to place it in the correct position.

	<p>Turn the axis locking knob to the left to unlock the axis.</p>
	
<p>Turn the RA axis 180°</p>	<p>Turn the axis locking knob to the right to lock the axis.</p>
	

3 Latitude Range Adjustment

The Nebula 6 can work at latitudes range from 20° to about 57°. For compactness purposes, the supplied is mount preset at about 40° and therefore the first operation to perform is the regulation of the latitude to the value related to the site in which the mount will be used. The same operations will be carried out in the case the mount is transferred in a site with a different value of latitude.

This section describes in detail the procedures to set the correct range of latitudes depending of the site where the mount will be used. The latitude range setting must be performed before installing the mount on the tripod.

The mount is provided of three different latitude range as described below:

- Position 1 between 57° and 41°
- Position 2 between 41° and 25°
- Position 3 between 27° and 10°

The mount is shipped with the latitude adjustment bar set on the position 1. In case it will be necessary to swap from a range to another, it will be required to change the latitude range bar slot. This adjustment requires the 6 mm, 5 mm and 4 mm Allen wrenches.

The operations required to adjust the range of useful latitudes are as follows:

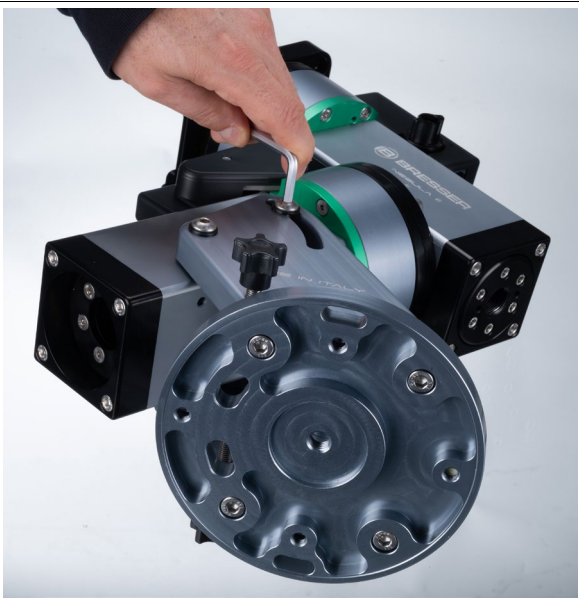
Place the mount on a flat and anti-scratch surface, as the squared foam provided with the package	
Loose of about half turn the two left lateral bracket fixing bolts	Turn the mount on the other side Loose of about half turn the two right lateral bracket fixing knob
	
Remove the four M8 bolts to take off the mount base flange.	Remove the two bolts that fix the mount base left lateral side on the mount RA axis



Remove one of the two lateral bracket



Remove the latitude adjustment bar and place it in the required position on depending on the user latitude observatory location.

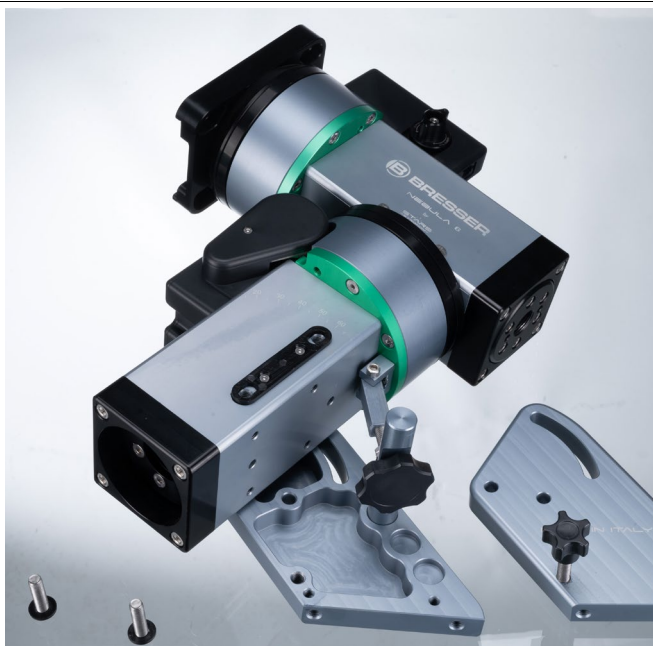

Put back and fix the previously removed lateral bracket



Put back the mount base flange previously removed and fix it tightening carefully the four M8 bolts.

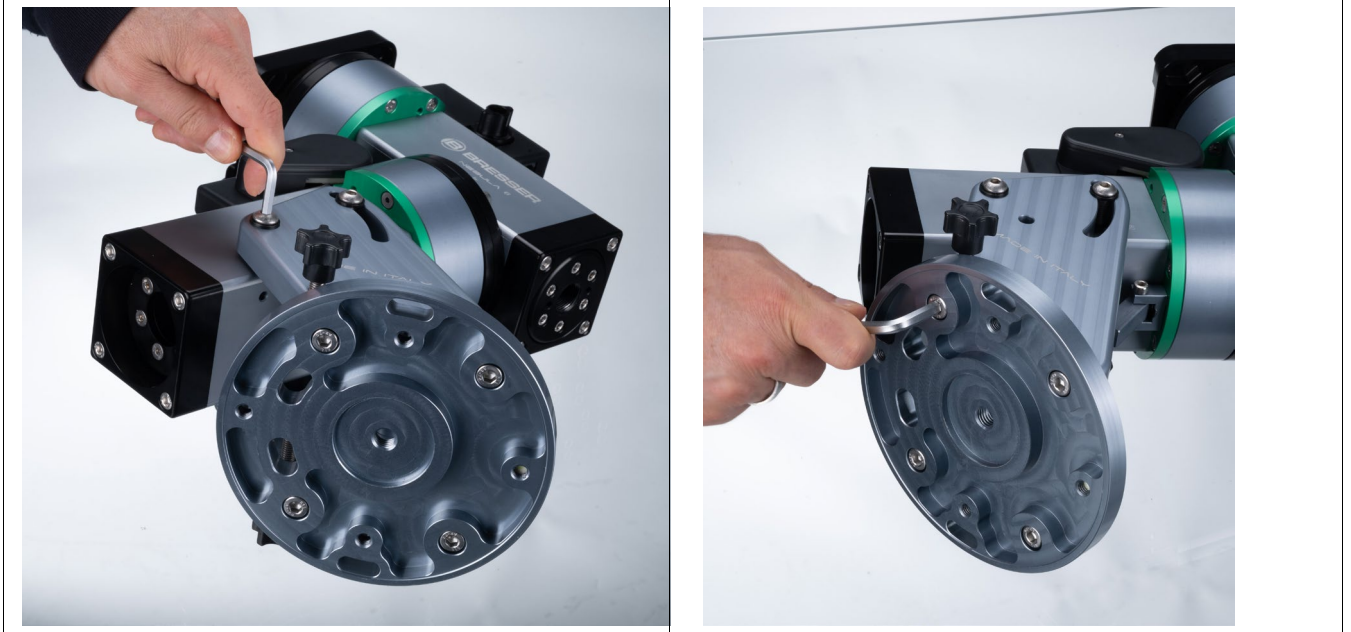

After the rough latitude range has been set, it will be possible to set the fine latitude by rotating the latitude adjustment knob.



NOTE: The latitude fine adjustment must be accomplished with the four fixing lateral brackets bolts loosened. When the latitude has been set, they must be tightened again.

4 Installing the Nebula 6 on the Tripod

When the latitude has been roughly and fine adjusted, it is possible to install the mount on the tripod.

Take out the tripod from the box	Place it on the floor in stand up position
	
Spread the legs	Press the central divider until it blocks the three legs
	
Use the blocking legs knob to adjust the tripod height	
	

When the tripod is opened, sturdily blocked with the legs height adjusted by the user, is possible to install the mount.

Prior to put the mount on the tripod is required to install the two azimuth pin provided in the package.

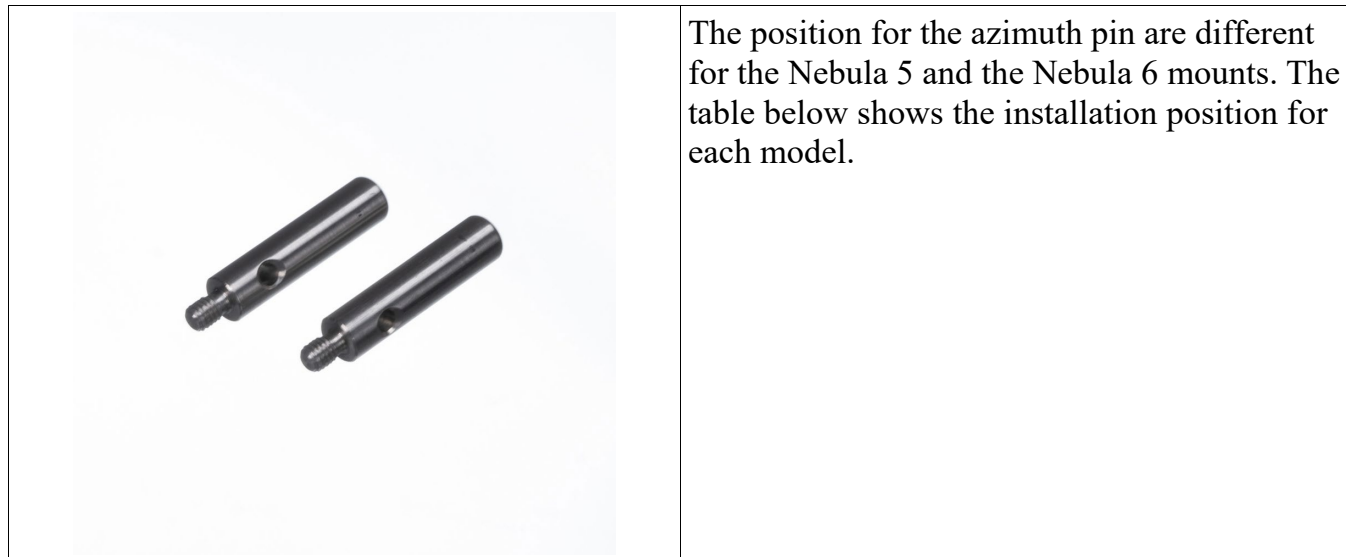

NEBULA 6 AZIMUTH PIN INSTALLATION POSITIONS

Considering the northern leg the one with the Nebula Tripod logo, the two threaded that must be used for the Nebula 6 mount azimuth pin are the latest two holes on the southern side.

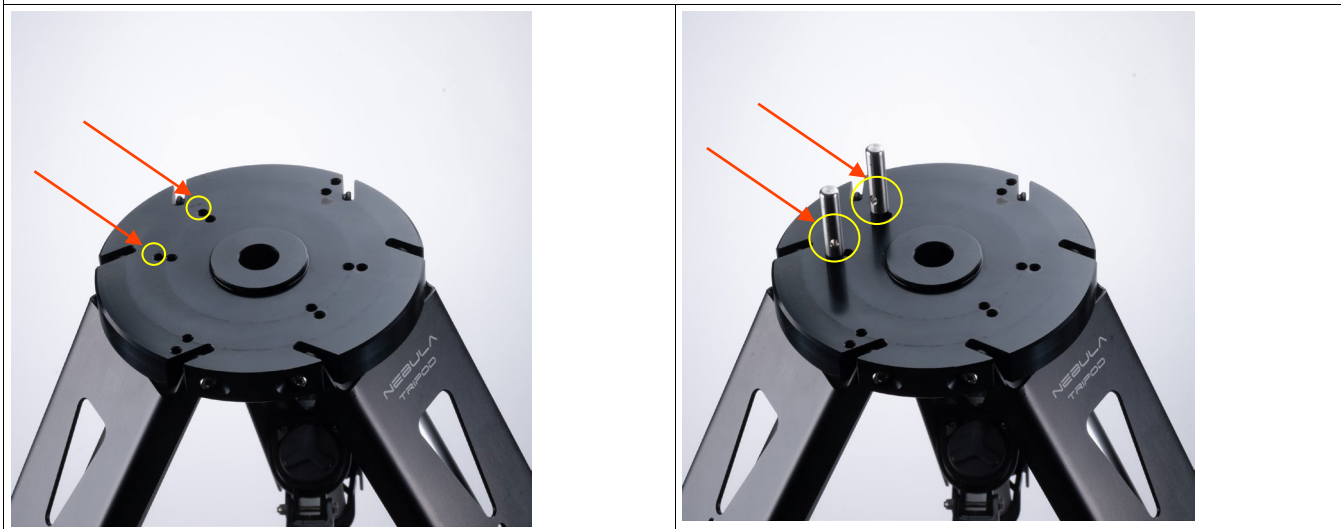

NEBULA 5 AZIMUTH PIN INSTALLATION POSITIONS

The Nebula 5 azimuth pin are placed next to the two threaded holes required for the Nebula 6 azimuth as shown in the pictures below.



5. Install the mount on the tripod

When the tripod is ready, install the mount on it.

<p>Release the azimuth adjustment knobs</p>	<p>The mount base slot holes must match with the azimuth adjustment pins installed on the tripod</p>	<p>Put the mount on the tripod and tight the two azimuth adjustment knobs on the corresponding pins</p>
		
<p>Take the two mount fixing knobs provided in the package</p>	<p>The slot holes must match with the corresponding threads</p>	<p>Screw the knobs to fix the mount</p>
		

6. Install the counterweight shaft

Now the mount is sturdily installed on the tripod. In order to have a balanced setup, before to put the telescope, is required to install the counterweight with it's shaft.

Take off the counterweight shaft from the package



The counterweight shaft installation is performed by screwing it inside it's housing.



7. Install the counterweights

The Nebula 6 mount comes provided in the package with 6 Kg counterweight. Remove the counterweight security knob on the shaft bottom to slide up the counterweight.

1 x 6kg counterweight provided	Loose the attaching knob to slide up the counterweight
	
Tight the attaching knob	Screw back the security knob
	

8. Install the Nebula the GoTo System on the Nebula Tripod

The Nebula mount comes with the Nebula GoTo System included in the package. The controller can be easily installed in a comfortable position, attached to one tripod leg. Below is explained the installing procedure.

Prepare the controller with the required 2X M5x10 fixing screws included in the package



The controller can be fixed on any tripod leg. In our sample we installed on the left leg (considering the one with the logo as the leg pointing to the North).



Place the controller rear side on the preferred leg making match the leg with the controller fixing holes.



Use the provided screws to fix it on the leg from the internal leg side.





9. Motor cable connecting

The kit comes with two cables with different length:
The longer cable is for the DEC (115 cm), the shorter cable is for the RA (80 cm).
The reason for the different length is to avoid cable stretching during the DEC rotation.

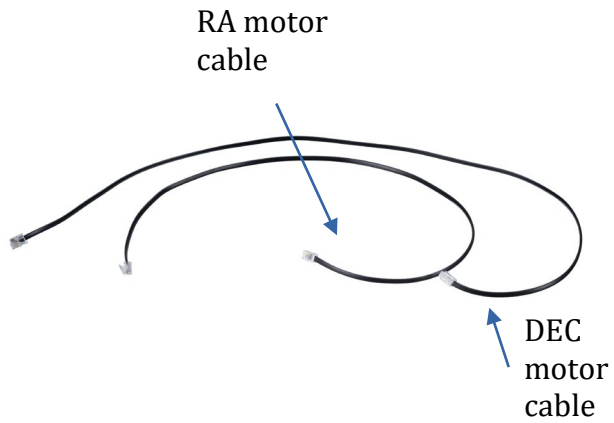

Service

DE AT CH BE

Bei Fragen zum Produkt und eventuellen Reklamationen nehmen Sie bitte zunächst mit dem Service-Center Kontakt auf, vorzugsweise per E-Mail.

E-Mail: service@bresser.de
Telefon*: +49 28 72 80 74 210

BRESSER GmbH

Kundenservice
Gutenbergstr. 2
46414 Rhede
Deutschland

*Lokale Rufnummer in Deutschland (Die Höhe der Gebühren je Telefonat ist abhängig vom Tarif Ihres Telefonanbieters); Anrufe aus dem Ausland sind mit höheren Kosten verbunden.

GB IE

Please contact the service centre first for any questions regarding the product or claims, preferably by e-mail.

E-Mail: service@bresseruk.com
Telephone*: +44 1342 837 098

BRESSER UK Ltd.

Suite 3G, Eden House
Enterprise Way
Edenbridge, Kent TN8 6HF
Great Britain

*Number charged at local rates in the UK (the amount you will be charged per phone call will depend on the tariff of your phone provider); calls from abroad will involve higher costs.

FR BE

Si vous avez des questions concernant ce produit ou en cas de réclamations, veuillez prendre contact avec notre centre de services (de préférence via e-mail).

E-Mail: sav@bresser.fr
Téléphone*: 00 800 6343 7000

BRESSER France SARL

Pôle d'Activités de Nicopolis
314 Avenue des Chênes Verts
83170 Brignoles
France

*Prix d'un appel local depuis la France ou Belgique

NL BE

Als u met betrekking tot het product vragen of eventuele klachten heeft kunt u contact opnemen met het service centrum (bij voorkeur per e-mail).

E-Mail: info@bresserbenelux.nl
Telefoon*: +31 528 23 24 76

BRESSER Benelux

Smirnoffstraat 8
7903 AX Hoogeveen
The Netherlands

*Het telefoonnummer wordt in het Nederland tegen lokaal tarief in rekening gebracht. Het bedrag dat u per gesprek in rekening gebracht zal worden, is afhankelijk van het tarief van uw telefoon provider; gesprekken vanuit het buitenland zullen hogere kosten met zich meebrengen.

ES PT

Si desea formular alguna pregunta sobre el producto o alguna eventual reclamación, le rogamos que se ponga en contacto con el centro de servicio técnico (de preferencia por e-mail).

E-Mail: servicio.iberia@bresser-iberia.es
Teléfono*: +34 91 67972 69

BRESSER Iberia SLU

c/Valdemorillo,1 Nave B
P.I. Ventorro del Cano
28925 Alcorcón Madrid
España

*Número local de España (el importe de cada llamada telefónica dependen de las tarifas de los distribuidores); Las llamadas des del extranjero están ligadas a costes suplementarios..

Bresser GmbH
Gutenbergstraße 2
46414 Rhede · Germany
www.bresser.de

   @BresserEurope

Bresser UK Ltd.
Suite 3G, Eden House
Enterprise Way, Edenbridge,
Kent TN8 6HF, Great Britain

